

PRODUCT CARE AND HANDLING

- KKDC products are delivered in appropriate packaging. Any handling instructions on the packaging must be observed. Products should remain in packaging 'as delivered' until installation or for ongoing transportation and storage.
- Inspect products carefully before installation. Do not proceed to install any product that may have been damaged in transportation, storage or handling.
- Handle with care. Many KKDC products contain precision electrical components and are not designed to withstand excessive stresses from tension or compression.
- Please follow standard ESD (Electrostatic discharge) protection measures when handling and installing KKDC LED products.

SAFETY AND WARRANTY

- Installation is only to be carried out by suitably qualified persons in accordance with installation instructions and all applicable regulations or standards. (Improper installation can create an electrical hazard with risk of electric shock, fire or injury).
- KKDC will not be held responsible for any consequences arising from improper product handling, storage or installation.
- KKDC products must be installed as supplied. Disassembly, modification or attempted repair will invalidate warranty and may create an electrical hazard.
- The KKDC product warranty is available with this document or on our website – www.kkdc.lighting.

PREPARATION

- Install KKDC products in accordance with the Wiring and Mounting instructions supplied with the product, using the recommended accessories, tools and fixings where specified.
- Product specification and installation information is also available from the KKDC website www.kkdc.lighting.
- Products should only be installed in areas appropriate to their IP rating, operable temperature and humidity range.
- Carefully plan and check the physical layout and circuit structure of the installation before starting work. Note wiring methods, cable type and connection points along with positioning and rating of power supplies and any control gear. Refer to all product information – including that for power supplies/control gear – and confirm choice of power supply, control gear, cable thickness and cable length.
- For safe and reliable operation KKDC LED products must only be used with suitable KKDC supplied or recommended power supplies and control gear. Contact KKDC for further information.
(North America – Use only UL listed Class 2 power supplies with KKDC products – See also Installation Guide – Wiring)
- The KKDC LED products in this guide require **12V DC** or **24V DC** 'constant voltage' power supplies as indicated in product specifications.

AFTER INSTALLATION

- KKDC products are designed to be maintenance free however accumulated dust may be removed from the emitting surface of luminaires with careful use of a soft dry cloth.
- Ensure that paints, organic solvents and caustic or corrosive cleaning chemicals do not come into contact with KKDC products.
For example **DO NOT USE** –
 - Benzene, Toluene, Xylene, Acetone, Carbon tetrachloride, Gasoline, Ether,
 - Sodium/Calcium hydroxide, Sodium Carbonate.
- For cleaning or sanitization – products in sealed IP rated housings may be wiped with a soft cloth dampened with an alcohol cleaner or with cool, soft water diluted (5% or less) bleach (Sodium Hypochlorite) solution.
- Please retain this information and pass to those responsible for installation/site maintenance.

READ BEFORE INSTALLATION

The mounting surface to which any KKDC product is attached must not carry any electrical potential and metallic surfaces must be earthed. Avoid physical contact between adjacent LED products.

Prepare, measure and mark the installation location and mounting surfaces before fixing. Any machining or drilling etc. should be completed before mounting. KKDC products and their immediate installation area should be kept clean, dry and free of paints and solvents during and after installation.

Ensure that products are mounted with supplied, recommended or appropriate screws and fixings to suit the surface material.

Mount products so that cables and connectors will not come under excessive stress and position accessories, wiring and connectors where they will not cast shadows.

North America – UL certification advice: Caution – To reduce risk of fire, do not install in any sealed compartment smaller than: 300mm (12 inches) x 300mm (12 inches) x Length of MOMO-R.

MOUNTING – SPRING CLIPS (FOR HOLLOW WALL/CEILING)



1

Cut-out 28-30mm (1.1-1.18") wide slot to the required length* and bring through the 24V power feed to make connection to MOMO-R.

*CUT-OUT LENGTH = Overall Product length minus 4-5mm.



2

Slide the spring clips to evenly distribute along the length and secure in position with grub screws.

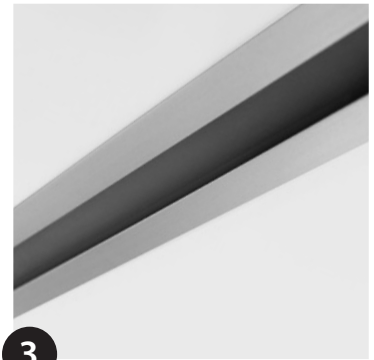

3

Compress spring clips, insert into cut-out. Ensure bezel sits tight to surface and is positioned to cover gaps.

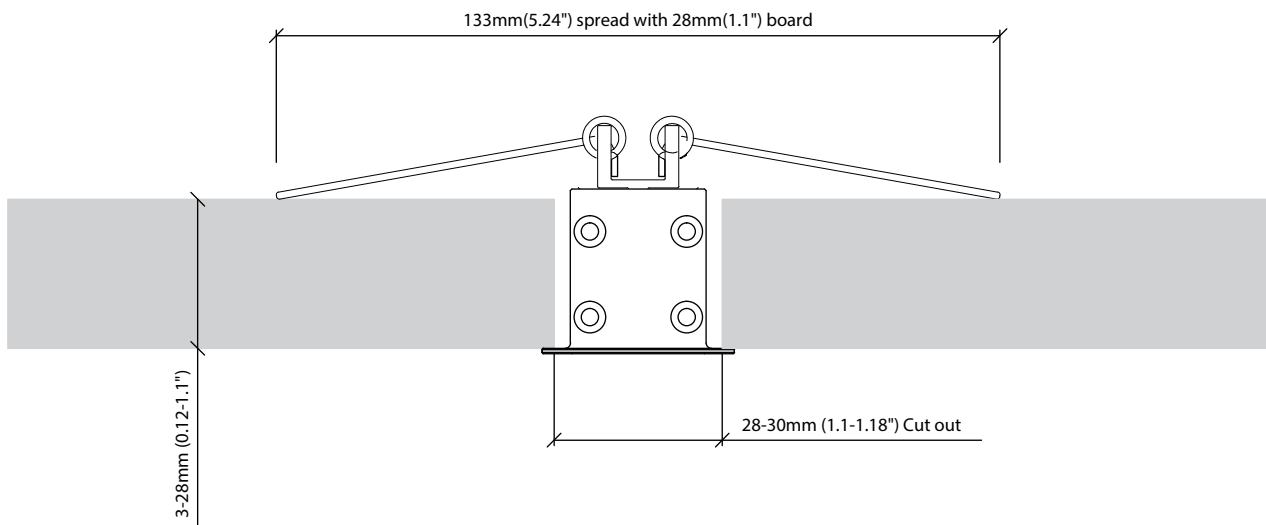

Note: This guide is produced from testing under 'average' conditions and does not represent all possible applications or installation circumstances. Please contact KKDC for further information. KKDC may change product specifications and installation guidance without prior notice.

READ BEFORE INSTALLATION

- Cables used for connecting KKDC products must be of a suitable type and recommended gauge. Cable insulation must remain undamaged and conductors free from dirt and corrosion.
- Control cables should be of a suitable shielded type and not fixed in proximity to high voltage power cables or other sources of electromagnetic interference.
- When connecting KKDC products always observe the correct polarity (+/-). Failure to do so may destroy the product.
- Electrical circuits should be wired with power off and all wiring and connections should be complete and checked thoroughly before power is switched on. Take particular care not to confuse any control and power wiring. Do not remove any supplied product cable labels.
- Power supplies should not be made 'live' without the correct load attached and the low voltage output must not be switched. Do not exceed the recommended load.
- Remove only the minimum of cable insulation necessary to make wiring connections to eliminate the possibility of short circuit.
- Cables should be joined with terminal blocks and adequately protected against water immersion or moisture ingress with suitable tapes and sealants, potting compounds and IP rated junction boxes as appropriate to the installation and operating environment.
- The LED products in this guide require **24V DC** (constant voltage) Class 2 power supplies (UL listed – for North America).
- When connecting **R030** products end to end – **Do not exceed 2m/6.56ft** (from any one parallel power feed – see wiring examples).

WIRING EXAMPLES

Switched

	Cable size / Max distance (d)				
	0.5mm ² / 20AWG	0.75mm ² / 18AWG	1.0mm ² / 17AWG	1.5mm ² / 15AWG	2.5mm ² / 13AWG
R030 (2.5m/8.20ft max) + 100W PSU	14m/45ft	21m/68ft	28m/91ft	42m/137ft	70.5m/231ft

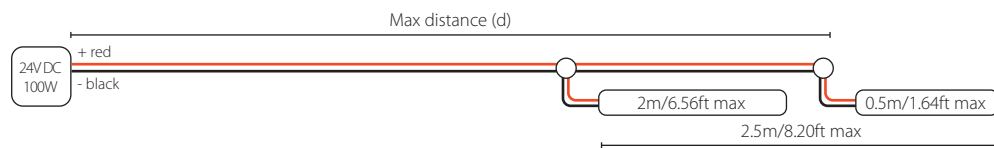

1-10V Dimming

	Cable size / Max distance (d)				
	0.5mm ² / 20AWG	0.75mm ² / 18AWG	1.0mm ² / 17AWG	1.5mm ² / 15AWG	2.5mm ² / 13AWG*
R030 (2.5m/8.20ft max) + 100W PSU + 1-10V Dimming	11m/36ft	17.5m/57ft	24.5m/80ft	37.5m/123ft	64m/209ft

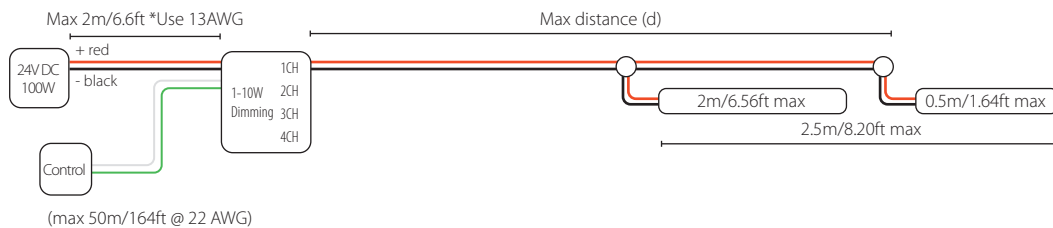

Note: This guide is produced from testing with KKDC approved power supplies or control gear.
Performance with other power or control products cannot be guaranteed. Contact KKDC for further information.
KKDC may change product specifications and installation guidance without prior notice.

DALI Dimming

	Cable size / Max distance (d)				
	0.5mm ² / 20AWG	0.75mm ² / 18AWG	1.0mm ² / 17AWG	1.5mm ² / 15AWG	2.5mm ² / 13AWG*
R030 (2.5m/8.20ft max) + 100W PSU + DALI Dimming	10.5m/34ft	17m/55ft	23.5m/77ft	36.5m/119ft	62m/203ft

*KKDL-02 only

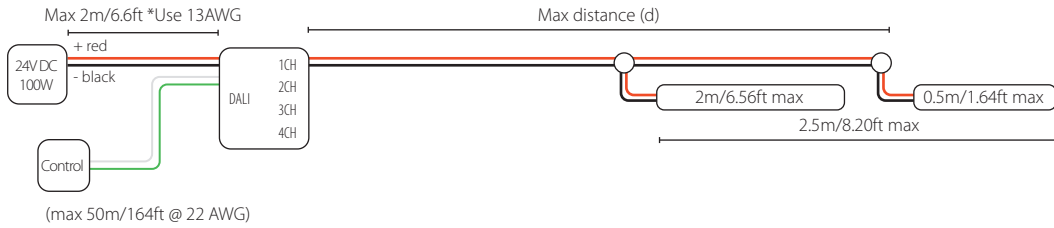

DMX Dimming

	Cable size / Max distance (d)				
	0.5mm ² / 20AWG	0.75mm ² / 18AWG	1.0mm ² / 17AWG	1.5mm ² / 15AWG	2.5mm ² / 13AWG*
R030 (2.5m/8.20ft max) + 100W PSU + DMX Dimming	10.5m/34ft	17m/55ft	23.5m/77ft	36.5m/119ft	62m/203ft

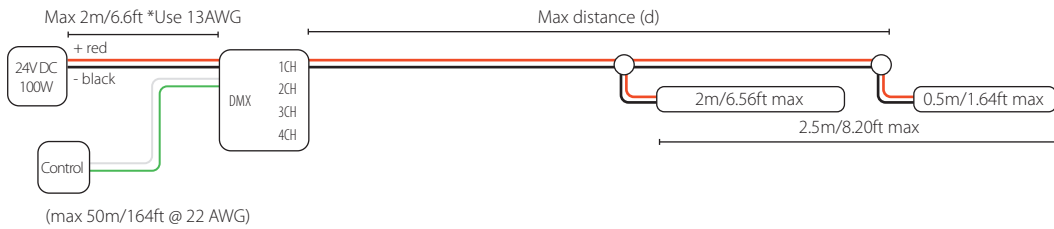

Note: This guide is produced from testing with KKDC approved power supplies or control gear. Performance with other power or control products cannot be guaranteed. Contact KKDC for further information. KKDC may change product specifications and installation guidance without prior notice.

READ BEFORE INSTALLATION

- Cables used for connecting KKDC products must be of a suitable type and recommended gauge. Cable insulation must remain undamaged and conductors free from dirt and corrosion.
- Control cables should be of a suitable shielded type and not fixed in proximity to high voltage power cables or other sources of electromagnetic interference.
- When connecting KKDC products always observe the correct polarity (+/-). Failure to do so may destroy the product.
- Electrical circuits should be wired with power off and all wiring and connections should be complete and checked thoroughly before power is switched on. Take particular care not to confuse any control and power wiring. Do not remove any supplied product cable labels.
- Power supplies should not be made 'live' without the correct load attached and the low voltage output must not be switched. Do not exceed the recommended load.
- Remove only the minimum of cable insulation necessary to make wiring connections to eliminate the possibility of short circuit.
- Cables should be joined with terminal blocks and adequately protected against water immersion or moisture ingress with suitable tapes and sealants, potting compounds and IP rated junction boxes as appropriate to the installation and operating environment.
- The LED products in this guide require **24V DC** (constant voltage) Class 2 power supplies (UL listed – for North America).
- When connecting **R030** products end to end – **Do not exceed 2m/6.56ft** (from any one parallel power feed – see wiring examples).

WIRING EXAMPLES

Switched

	Cable size / Max distance (d)				
	0.5mm ² / 20AWG	0.75mm ² / 18AWG	1.0mm ² / 17AWG	1.5mm ² / 15AWG	2.5mm ² / 13AWG
R030 (6.5m/21.33ft) + 240W PSU	-	8m/26ft	10.5m/34ft	16m/52ft	27m/88ft

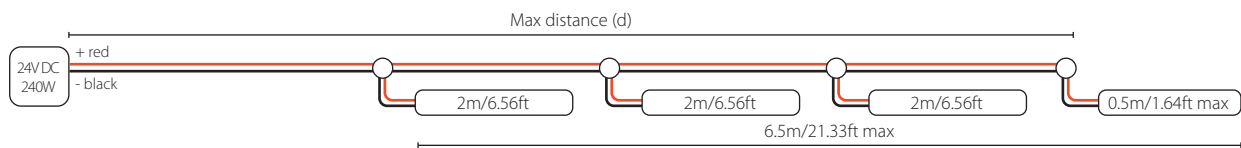

1-10V Dimming

	Cable size / Max distance (d)				
	0.5mm ² / 20AWG	0.75mm ² / 18AWG	1.0mm ² / 17AWG	1.5mm ² / 15AWG	2.5mm ² / 13AWG*
R030 (6.5m/21.33ft) + 240W PSU + 1-10V Dimming	5.5m/18ft	10.5m/34ft	15m/49ft	24.5m/80ft	43.5m/142ft

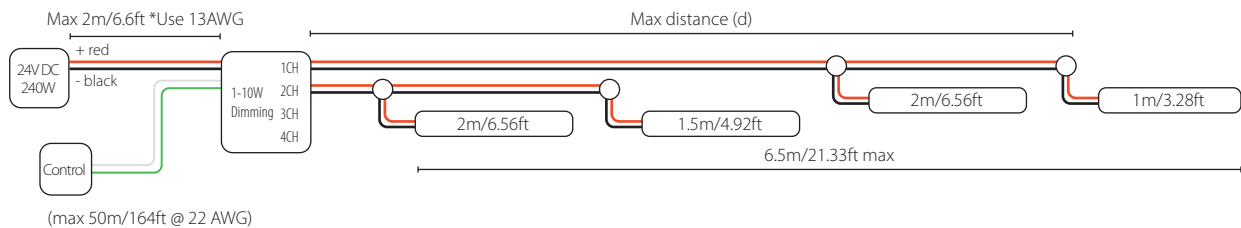

Note: This guide is produced from testing with KKDC approved power supplies or control gear.
Performance with other power or control products cannot be guaranteed. Contact KKDC for further information.
KKDC may change product specifications and installation guidance without prior notice.

R030 + 240W PSU Installation Guide – Wiring



DALI Dimming

	Cable size / Max distance (d)				
	0.5mm ² / 20AWG	0.75mm ² / 18AWG	1.0mm ² / 17AWG	1.5mm ² / 15AWG	2.5mm ² / 13AWG*
R030 (6.5m/21.33ft) + 240W PSU + DALI Dimming	5m/16ft	10m/32ft	14.5m/47ft	23.5m/77ft	42m/137ft

*KKDL-02 only

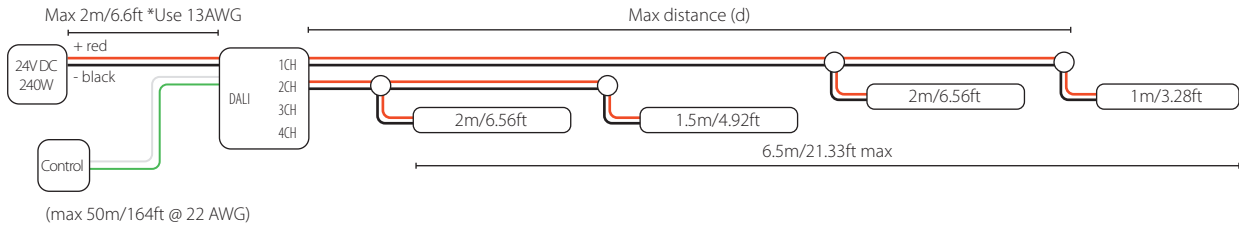

DMX Dimming

	Cable size / Max distance (d)				
	0.5mm ² / 20AWG	0.75mm ² / 18AWG	1.0mm ² / 17AWG	1.5mm ² / 15AWG	2.5mm ² / 13AWG*
R030 (6.5m/21.33ft) + 240W PSU + DMX Dimming	5m/16ft	10m/32ft	14.5m/47ft	23.5m/77ft	42m/137ft

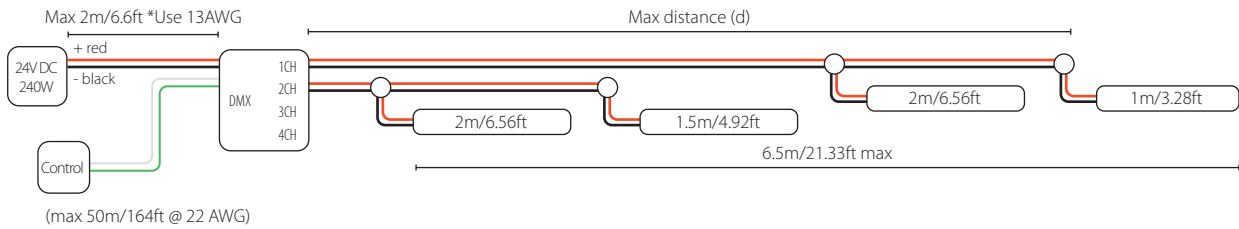

Note: This guide is produced from testing with KKDC approved power supplies or control gear.
Performance with other power or control products cannot be guaranteed. Contact KKDC for further information.
KKDC may change product specifications and installation guidance without prior notice.

Product Warranty



We believe we produce a superior product, and that your investment should be rewarded with years of trouble free operation. Through rigorous quality control and testing at every stage of manufacture we are confident that KKDC products will operate as intended. In the unlikely event that purchasers should experience a product failure, this should in the first instance be dealt with by contacting the supplier or local authorised KKDC representative. Our warranty is provided in addition to any statutory legal rights and details the terms under which claims can be made.

1. Duration of the Warranty

This warranty applies to all KKDC manufactured products for 3 years from the date of shipment. An extended 5 year warranty may be offered at the discretion of KKDC if appropriate project registration criteria are met.

2. Repair/Replacement

Should a KKDC product fail to function within the warranty period, KKDC will on its sole discretion provide a replacement free of charge or repair defective components in accordance with the terms set out below. Purchasers shall bear the cost of removal and return of any product subject to a warranty claim and that of installing a replacement. Any other costs, including but not limited to replacement costs upon installation; costs caused from failures of the installation or other damages and/or consequential damages are not covered by this warranty. Replacement products shall as far as possible match the specification of the original but may have superior performance characteristics in line with ongoing product development.

3. Return of defective Product

The purchaser making a warranty claim shall contact KKDC (or their authorised representative) at the earliest opportunity to be provided with an address for return of the product. On receipt of returned product/s the validity of the claim will be checked. Proof of purchase may be required.

KKDC reserve the right to conduct diagnostic examination of any defective or failed product to determine patterns of usage and cause of failure and reserve the right to be the sole judge as to whether a returned product is defective within the terms of this warranty.

4. Notes / Conditions of Warranty

This warranty applies only to defects in materials and workmanship and only where KKDC Products are properly handled, stored, installed, wired and maintained in accordance with the most recent published KKDC product usage guides, installation instructions, specification sheets, and any applicable local electrical safety standards and wiring regulations. (The most recent versions of KKDC product documentation are available from the website - www.kkdc.lighting).

This warranty does not constitute any inference as to the suitability of any product for any purpose. In no event shall KKDC be liable for any other costs or damages including lost profits, incidental, special or consequential damages.

Warranty will not apply in the event of;

- Product damage due to abuse, unauthorised alteration, modification, accident, natural disasters and acts of God.
- Product installation by unqualified persons.
- Product modification, disassembly or attempted repair by non KKDC staff.
- Product installation or storage in 'abnormal' conditions or locations, including but not limited to those where :
 - Ambient Temperatures are in excess of 50°C (please refer to precise specification for each product).
 - There is excessive humidity.
 - Any product has been subjected to excessive mechanical stress, or physical damage.
 - Inadequate heat sinking is provided for any unboxed 'bare PCB' type LED product.
 - IP67 class luminaires are installed without adequate local drainage, or become immersed in water.
- Chemical contamination or damage from salt laden air.
- Damage from use of pressure washers or other mechanical cleaners.
- Improper use of 'sanitizing products' and maintenance using improper or unapproved chemical compounds/solvents.
- Unauthorised use of parts or accessories not manufactured by KKDC in conjunction with KKDC Products.
- 'Constant Voltage' (CV) KKDC LED Products are supplied with incorrect voltage.
- 'Constant Current' (CC) KKDC LED products are supplied with incorrect current.
- Incorrect layout, cutting and connection of wiring; intermittent or improper mains electrical supply.
- Product/s having damaged serial number, cable or Certificate labels.
- Product/s which have been installed more than once or have not been returned promptly and directly to KKDC for fault diagnosis and testing.
- Product/s discolored and/or deformed due to the natural environment and lifetime.
- Product/s installed in special/extreme environmental conditions (Such as: in Sub-zero polar regions / in desert regions on the equator / underwater deeper than 5m).
- Product/s not installed in accordance with KKDC installation and wiring guides.

5. Warranty contacts

Warranty claims can be made only by the original purchaser by contacting KKDC or local KKDC authorised representative details of which can be found via the supplier or on the website – www.kkdc.lighting

6. Implied Terms

- 6.1 Subject to sub-clause 6.2, any condition or warranty which would otherwise be implied is excluded.
- 6.2 Where legislation implies any condition or warranty, and that legislation avoids or prohibits provisions in a contract excluding or modifying the application of or exercise of or liability under such condition or warranty, the condition or warranty shall be deemed to be included in this warranty. However the liability of KKDC for any breach of such condition or warranty shall be limited, at the option of KKDC, to the following:

If the breach relates to any KKDC Product:

- (i) the replacement or the supply of equivalent KKDC Product;
- (ii) repair of product (excluding costs of removal and installation);
- (iii) payment of the cost of replacement or of acquiring equivalent product; or
- (iv) payment of the cost of repair of product (excluding costs of removal and installation).

Note: KKDC reserves the right to make changes to product specifications and installation guidance without prior notice.